

Power Designer

<http://www.brigidaarie.com>

Tutorial Power Designer

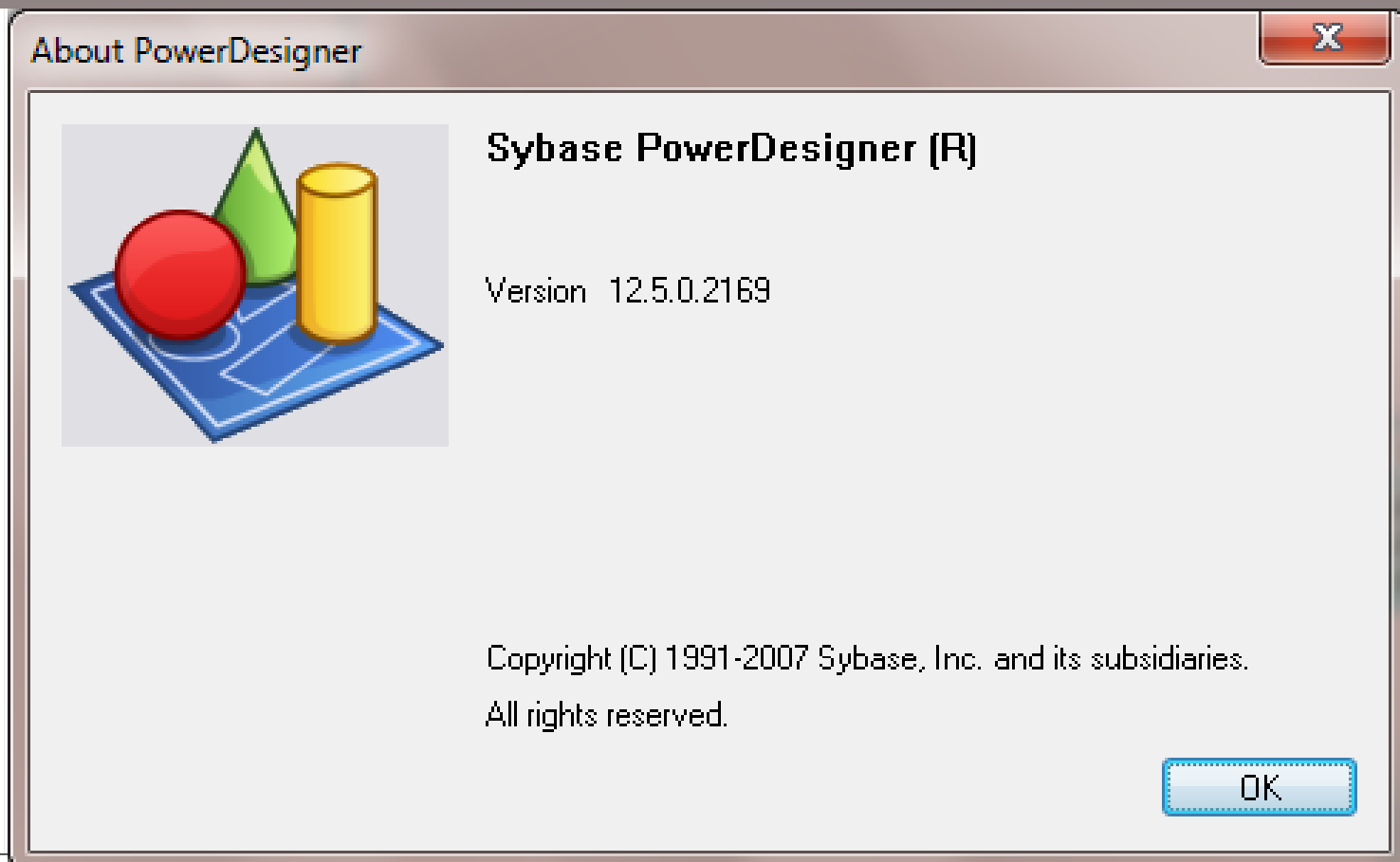

Klik File>New untuk memulai lembar kerja baru

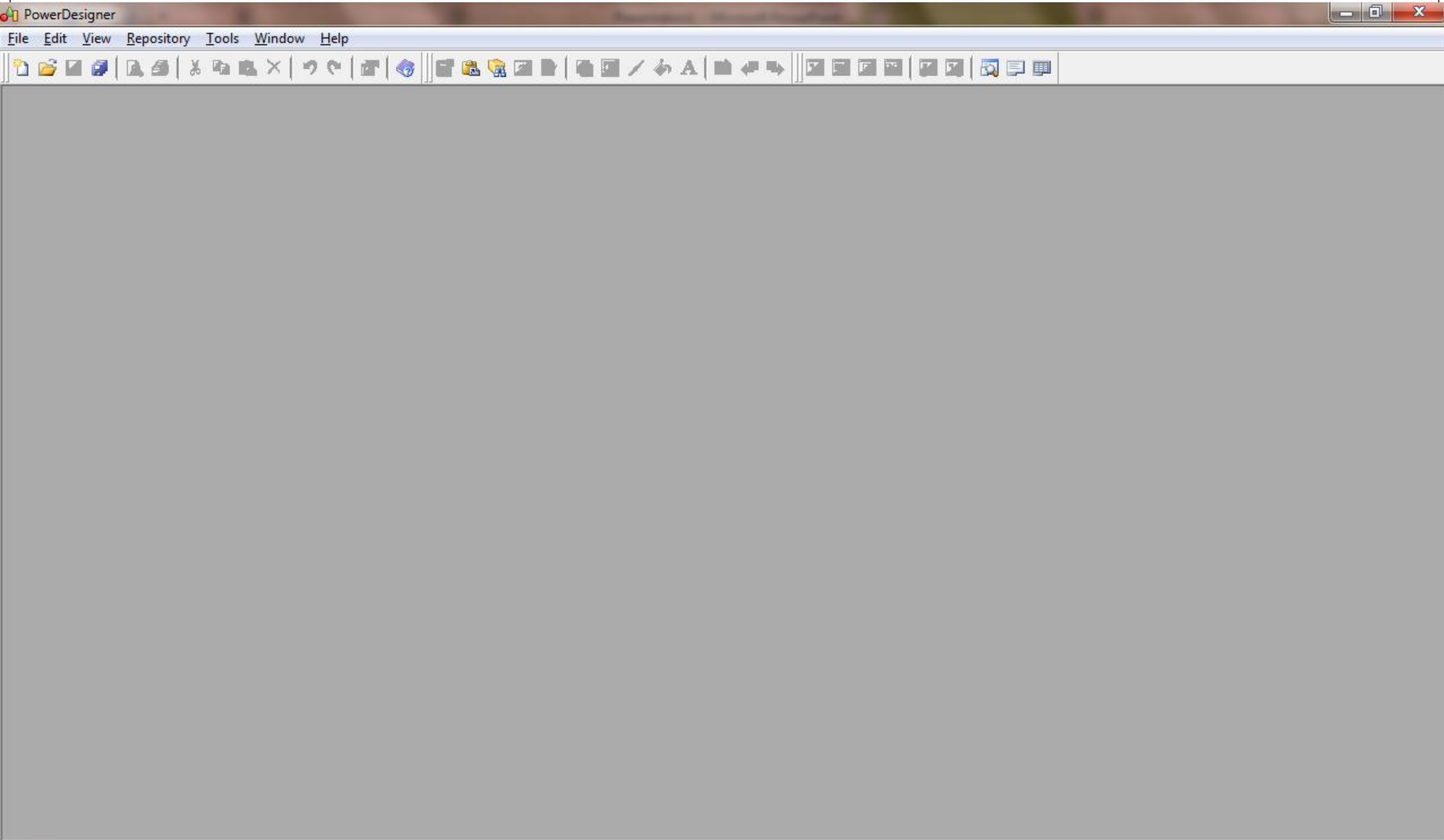

Pilih Conceptual Data Model

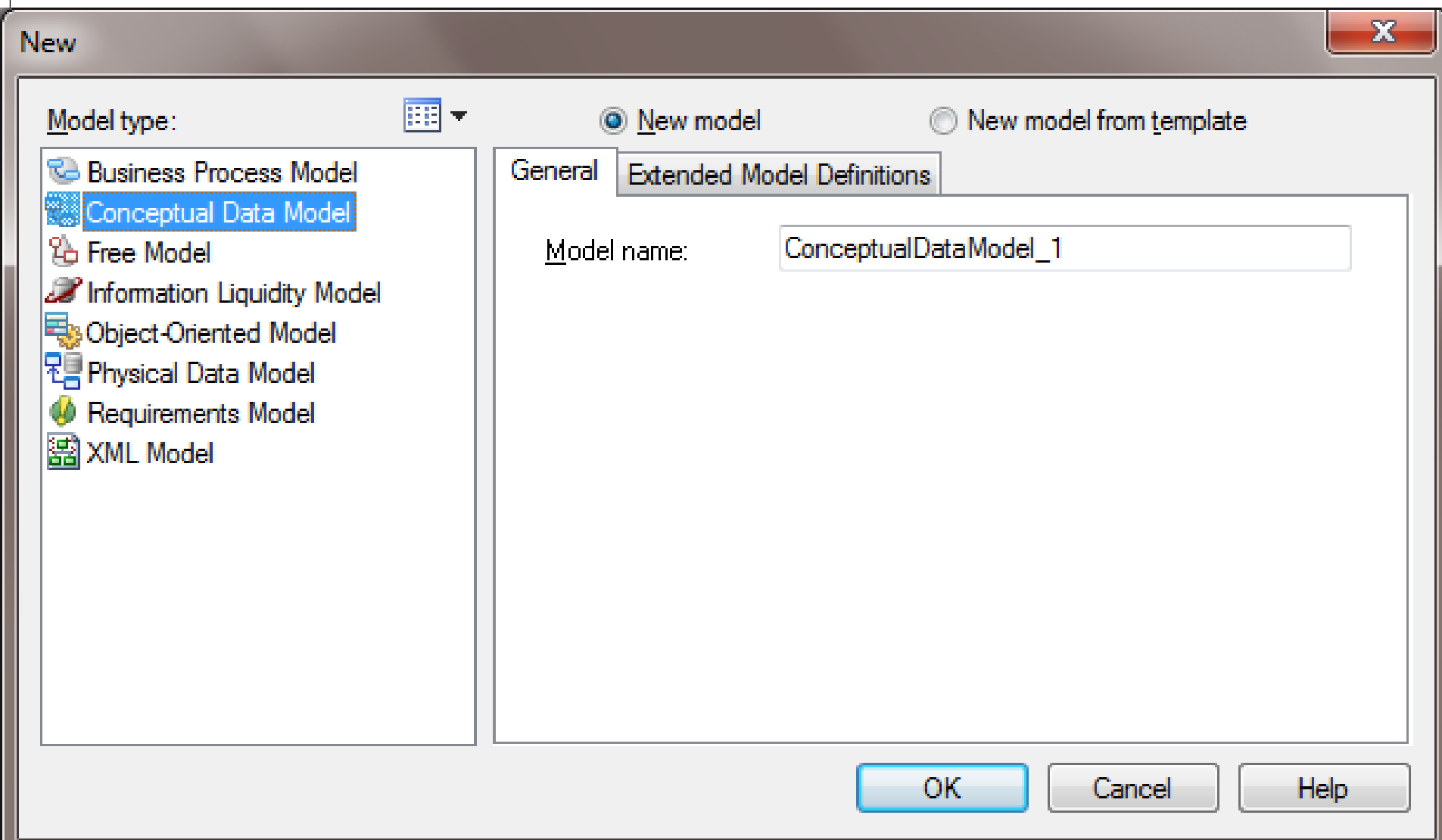

Lembar Kerja baru

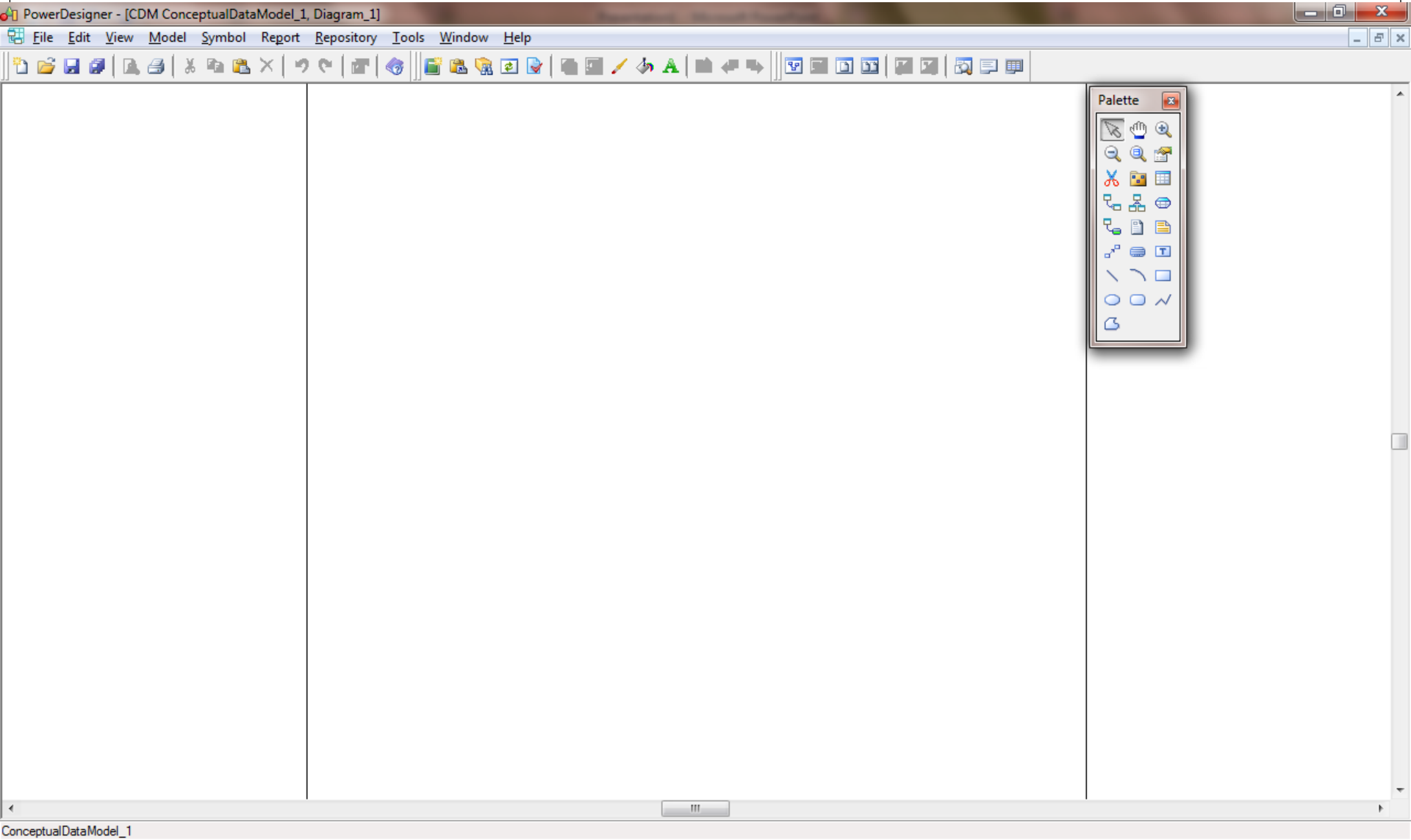

Tools yang digunakan untuk pembuatan Conceptual Data Model

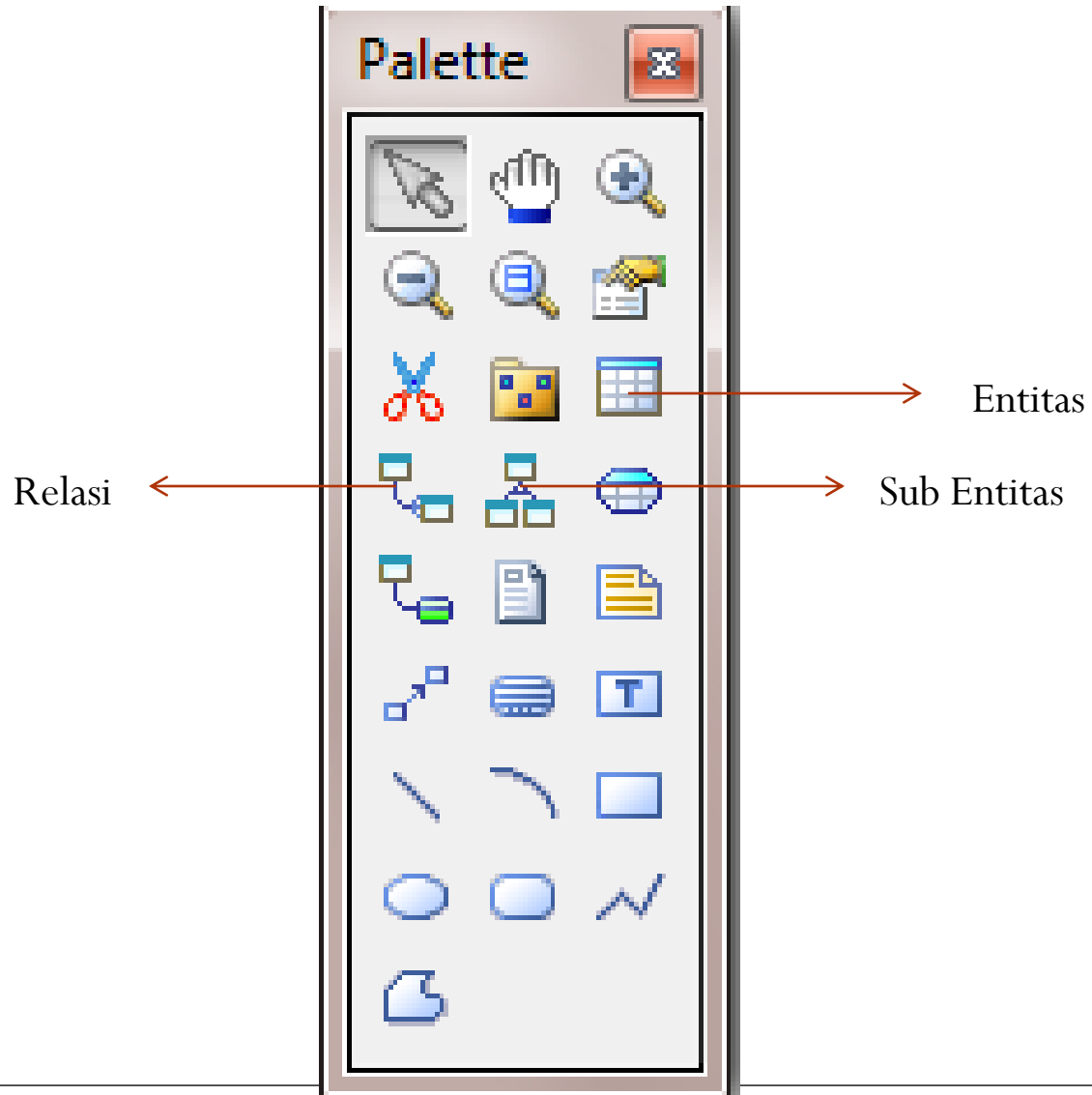

Entitas yang terbentuk pada CDM

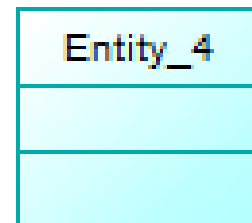
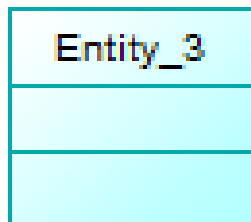
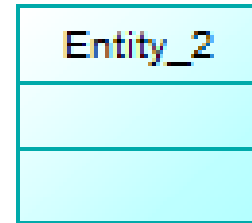
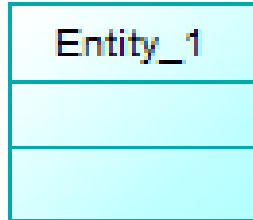

Klik kanan/double klik pada entitas untuk memodifikasi entitas tersebut

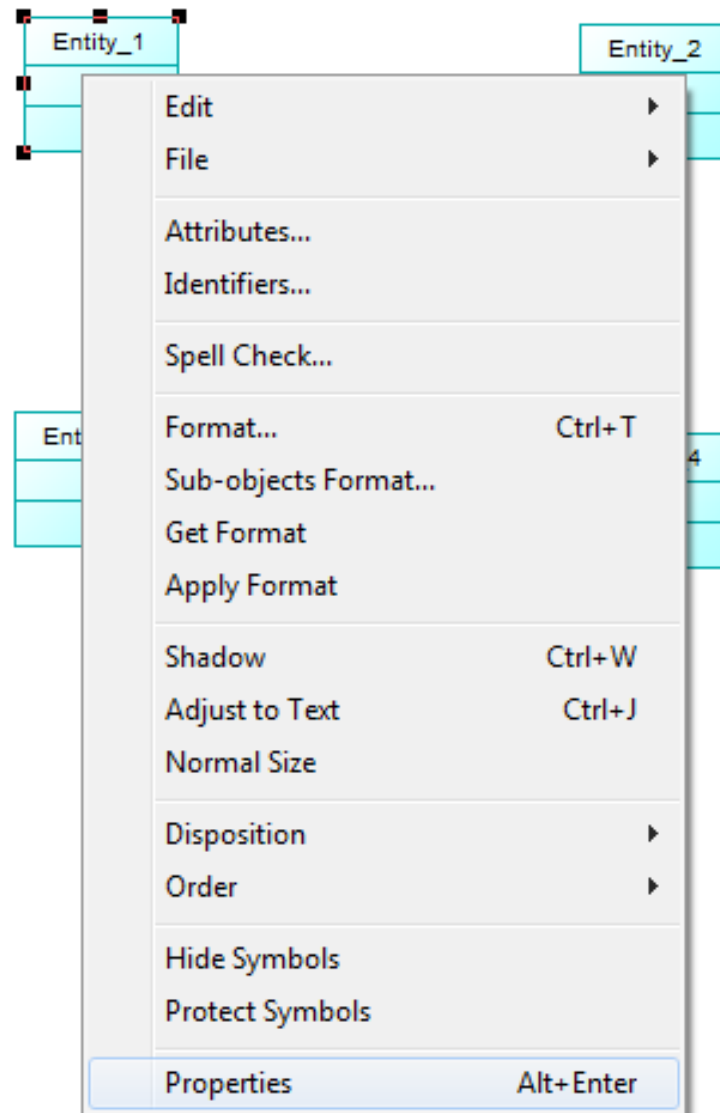

Mengganti nama entitas

The image shows a dialog box titled "Entity Properties - ()" with the following fields and controls:

- General** (selected tab), **Attributes**, **Identifiers**, **Notes**, **Rules**
- Name:** Input field containing "Departemen" with an equals sign button.
- Code:** Input field containing "DEPARTEMEN" with an equals sign button.
- Comment:** A large empty text area with a vertical scrollbar.
- Stereotype:** A dropdown menu.
- Number:** An empty input field next to a checked checkbox labeled "Generate".
- Buttons:** "More >>", a document icon with a dropdown arrow, "OK", "Cancel", "Apply", and "Help".

Modifikasi Atribut

Entity Properties - Departemen (DEPARTEMEN)

General Attributes Identifiers Notes Rules

Klik untuk memodifikasi tipe data

| | Name | Code | Data Type | Length | Precision | M | P |
|---|--------|--------|----------------|--------|-----------|-------------------------------------|-------------------------------------|
| 1 | kd_dep | KD_DEP | Characters (3) | 3 | | <input checked="" type="checkbox"/> | <input checked="" type="checkbox"/> |
| → | nm_dep | NM_DEP | Variable char | 15 | | <input checked="" type="checkbox"/> | <input type="checkbox"/> |
| | | | | | | <input type="checkbox"/> | <input type="checkbox"/> |
| | | | | | | <input type="checkbox"/> | <input type="checkbox"/> |
| | | | | | | <input type="checkbox"/> | <input type="checkbox"/> |
| | | | | | | <input type="checkbox"/> | <input type="checkbox"/> |
| | | | | | | <input type="checkbox"/> | <input type="checkbox"/> |
| | | | | | | <input type="checkbox"/> | <input type="checkbox"/> |
| | | | | | | <input type="checkbox"/> | <input type="checkbox"/> |
| | | | | | | <input type="checkbox"/> | <input type="checkbox"/> |
| | | | | | | <input type="checkbox"/> | <input type="checkbox"/> |
| | | | | | | <input type="checkbox"/> | <input type="checkbox"/> |
| | | | | | | <input type="checkbox"/> | <input type="checkbox"/> |
| | | | | | | <input type="checkbox"/> | <input type="checkbox"/> |
| | | | | | | <input type="checkbox"/> | <input type="checkbox"/> |
| | | | | | | <input type="checkbox"/> | <input type="checkbox"/> |
| | | | | | | <input type="checkbox"/> | <input type="checkbox"/> |
| | | | | | | <input type="checkbox"/> | <input type="checkbox"/> |
| | | | | | | <input type="checkbox"/> | <input type="checkbox"/> |
| | | | | | | <input type="checkbox"/> | <input type="checkbox"/> |
| | | | | | | <input type="checkbox"/> | <input type="checkbox"/> |

More >> OK Cancel Apply Help

Modifikasi tipe data dari atribut

Standard Data Types

Integer

Short integer

Long integer

Byte

Number

Decimal

Float

Short float

Long float

Money

Serial

Boolean

Characters

Variable characters

Long characters

Long var characters

Text

Multibyte

Variable multibyte

Date

Time

Date & time

Timestamp

Binary

Long binary

Bitmap

Image

OLE

Other

Undefined

Code:

Length:

Precision:

Mandatory. Primay Key, Display

The screenshot shows the 'Entity Properties' dialog for 'DEPARTEMEN' with the 'Attributes' tab selected. It displays a table of attributes with columns for Code, Data Type, Length, Precision, and checkboxes for M (Mandatory), P (Primary), and D (Display). The 'KD_DEP' attribute is marked as Primary, Mandatory, and Display. The 'NM_DEP' attribute is marked as Mandatory and Display. Red arrows point to these checkboxes with labels: 'Primary key' points to the 'P' checkbox for 'KD_DEP', 'Not Null' points to the 'M' checkbox for 'NM_DEP', and 'Display' points to the 'D' checkbox for 'NM_DEP'.

| | Code | Data Type | Length | Precision | M | P | D | Domain |
|---|--------|---------------|--------|-----------|-------------------------------------|-------------------------------------|-------------------------------------|--------|
| → | KD_DEP | Chara | 3 | | <input checked="" type="checkbox"/> | <input checked="" type="checkbox"/> | <input checked="" type="checkbox"/> | <None> |
| 2 | NM_DEP | Variable char | 15 | | <input checked="" type="checkbox"/> | <input type="checkbox"/> | <input checked="" type="checkbox"/> | <None> |
| | | | | | <input type="checkbox"/> | <input type="checkbox"/> | <input type="checkbox"/> | |
| | | | | | <input type="checkbox"/> | <input type="checkbox"/> | <input type="checkbox"/> | |
| | | | | | <input type="checkbox"/> | <input type="checkbox"/> | <input type="checkbox"/> | |
| | | | | | <input type="checkbox"/> | <input type="checkbox"/> | <input type="checkbox"/> | |
| | | | | | <input type="checkbox"/> | <input type="checkbox"/> | <input type="checkbox"/> | |
| | | | | | <input type="checkbox"/> | <input type="checkbox"/> | <input type="checkbox"/> | |
| | | | | | <input type="checkbox"/> | <input type="checkbox"/> | <input type="checkbox"/> | |
| | | | | | <input type="checkbox"/> | <input type="checkbox"/> | <input type="checkbox"/> | |
| | | | | | <input type="checkbox"/> | <input type="checkbox"/> | <input type="checkbox"/> | |
| | | | | | <input type="checkbox"/> | <input type="checkbox"/> | <input type="checkbox"/> | |
| | | | | | <input type="checkbox"/> | <input type="checkbox"/> | <input type="checkbox"/> | |
| | | | | | <input type="checkbox"/> | <input type="checkbox"/> | <input type="checkbox"/> | |
| | | | | | <input type="checkbox"/> | <input type="checkbox"/> | <input type="checkbox"/> | |
| | | | | | <input type="checkbox"/> | <input type="checkbox"/> | <input type="checkbox"/> | |
| | | | | | <input type="checkbox"/> | <input type="checkbox"/> | <input type="checkbox"/> | |
| | | | | | <input type="checkbox"/> | <input type="checkbox"/> | <input type="checkbox"/> | |
| | | | | | <input type="checkbox"/> | <input type="checkbox"/> | <input type="checkbox"/> | |

Primary key
Not Null
Display

Entitas departemen dan atributnya

Departemen

| | | | |
|---------------|------|--------------------------|-----|
| <u>kd_dep</u> | <pi> | <u>Characters (3)</u> | <M> |
| nm_dep | | Variable characters (15) | |
| Identifier_1 | <pi> | | |

Entity_2

Entity_3

Entity_4

Seluruh entitas beserta atributnya

| Departemen | | | |
|-------------------|------|--------------------------|-----|
| <u>kd_dep</u> | <pi> | <u>Characters (3)</u> | <M> |
| nm_dep | | Variable characters (15) | |
| Identifier_1 <pi> | | | |

| Manajer | | | |
|-------------------|------|--------------------------|-----|
| <u>kd_mj</u> | <pi> | <u>Characters (3)</u> | <M> |
| nama_mj | | Variable characters (15) | |
| tgl_lahir_mj | | Date | |
| alamat_mj | | Variable characters (20) | |
| Identifier_1 <pi> | | | |

| Pegawai | | | |
|-------------------|------|--------------------------|-----|
| <u>kd_peg</u> | <pi> | <u>Characters (3)</u> | <M> |
| nm_peg | | Variable characters (15) | |
| tgl_lahir_peg | | Date | |
| alamat_peg | | Variable characters (20) | |
| Identifier_1 <pi> | | | |

| Proyek | | | |
|-------------------|------|--------------------------|-----|
| <u>kd_pry</u> | <pi> | <u>Characters (3)</u> | <M> |
| nm_pry | | Variable characters (15) | |
| lokasi_pry | | Variable characters (20) | |
| Identifier_1 <pi> | | | |

Membuat relasi

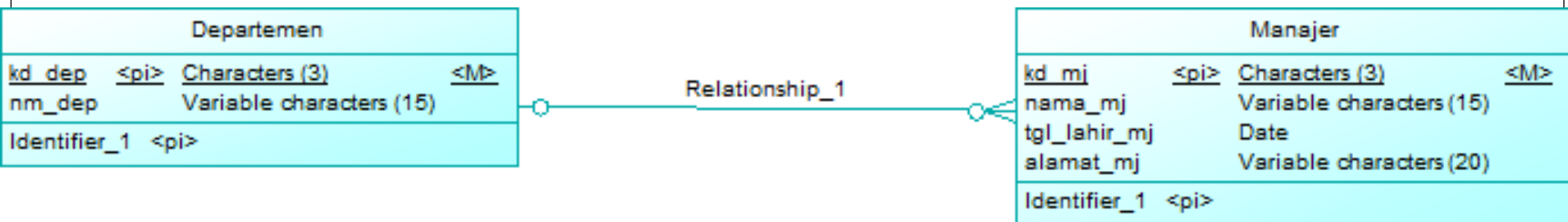

| Pegawai | | | |
|---------------|------|--------------------------|-----|
| <u>kd_peg</u> | <pi> | Characters (3) | <M> |
| nm_peg | | Variable characters (15) | |
| tgl_lahir_peg | | Date | |
| alamat_peg | | Variable characters (20) | |
| Identifier_1 | <pi> | | |

| Proyek | | | |
|---------------|------|--------------------------|-----|
| <u>kd_pry</u> | <pi> | Characters (3) | <M> |
| nm_pry | | Variable characters (15) | |
| lokasi_pry | | Variable characters (20) | |
| Identifier_1 | <pi> | | |

Modifikasi relasi

| Departemen | | | |
|---------------|------|--------------------------|-----|
| <u>kd_dep</u> | <pi> | Characters (3) | <M> |
| nm_dep | | Variable characters (15) | ■ |
| Identifier_1 | <pi> | | |

Relationship_1

| Manajer | | | |
|--------------|------|--------------------------|-----|
| <u>kd_mj</u> | <pi> | Characters (3) | <M> |
| nama_mj | | Variable characters (15) | |
| | | Variable characters (20) | |

| Pegawai | | | |
|---------------|------|--------------------------|-----|
| <u>kd_peg</u> | <pi> | Characters (3) | <M> |
| nm_peg | | Variable characters (15) | |
| tgl_lahir_peg | | Date | |
| alamat_peg | | Variable characters (20) | |
| Identifier_1 | <pi> | | |

- Edit
- File
- Detail...
- Change to Entity
- Spell Check...
- Format... Ctrl+T
- Get Format
- Apply Format
- Shadow Ctrl+W
- Disposition
- Order
- Hide Symbols
- Protect Symbols
- Properties Alt+Enter

Mengganti nama relasi

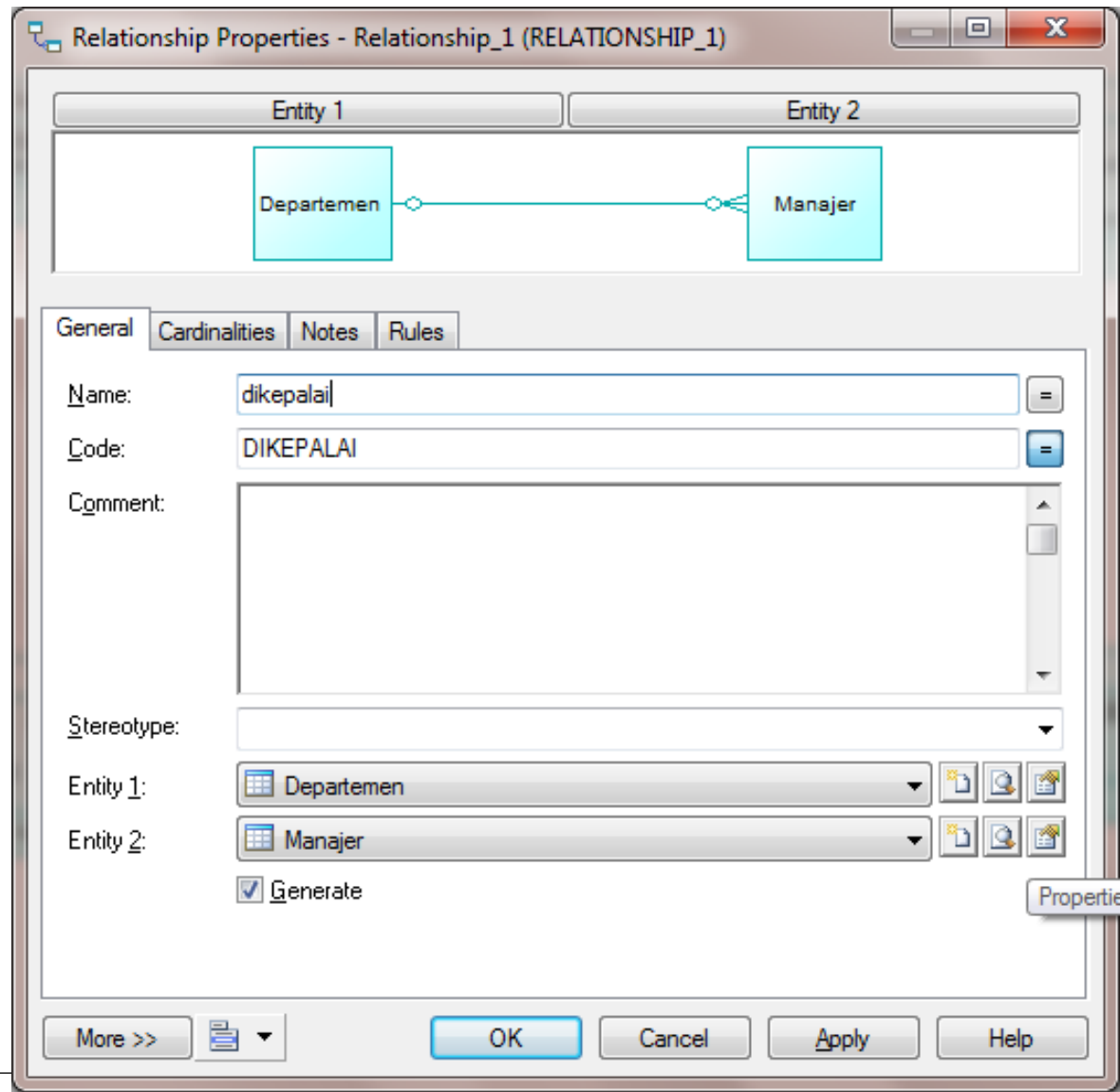

Menentukan Kardinalitas

Relationship Properties - dikepalai (DIKEPALAI)

Entity 1 Entity 2

Departemen Manajer

General Cardinalities Notes Rules

One - One One - Many Many - One Many - Many

Dominant role: <None>

Departemen to Manajer

Role name:

Dependent Mandatory Cardinality: 1,1

Manajer to Departemen

Role name:

Dependent Mandatory Cardinality: 1,1

More >>

Relasi One To One (Manajer to Departemen)



| Pegawai | | | |
|---------------|------|--------------------------|-----|
| <u>kd_peg</u> | <pi> | Characters (3) | <M> |
| nm_peg | | Variable characters (15) | |
| tgl_lahir_peg | | Date | |
| alamat_peg | | Variable characters (20) | |
| Identifier_1 | <pi> | | |

| Proyek | | | |
|---------------|------|--------------------------|-----|
| <u>kd_pry</u> | <pi> | Characters (3) | <M> |
| nm_pry | | Variable characters (15) | |
| lokasi_pry | | Variable characters (20) | |
| Identifier_1 | <pi> | | |

Hasil akhir seluruh relasi yang terbentuk

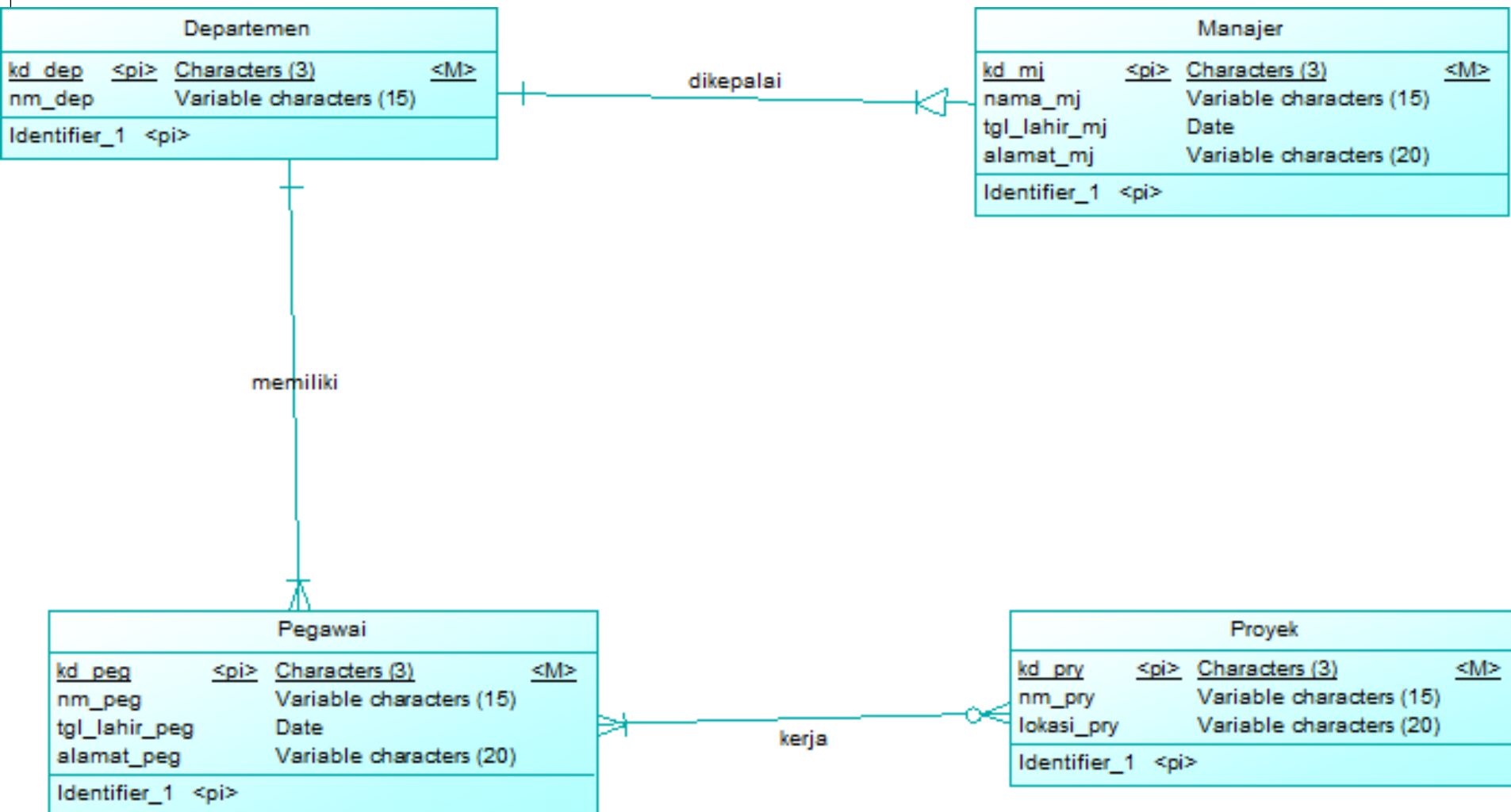

Klik kanan relasi kerja >>Change to Entity (Modifikasi Relasi Many to Many)

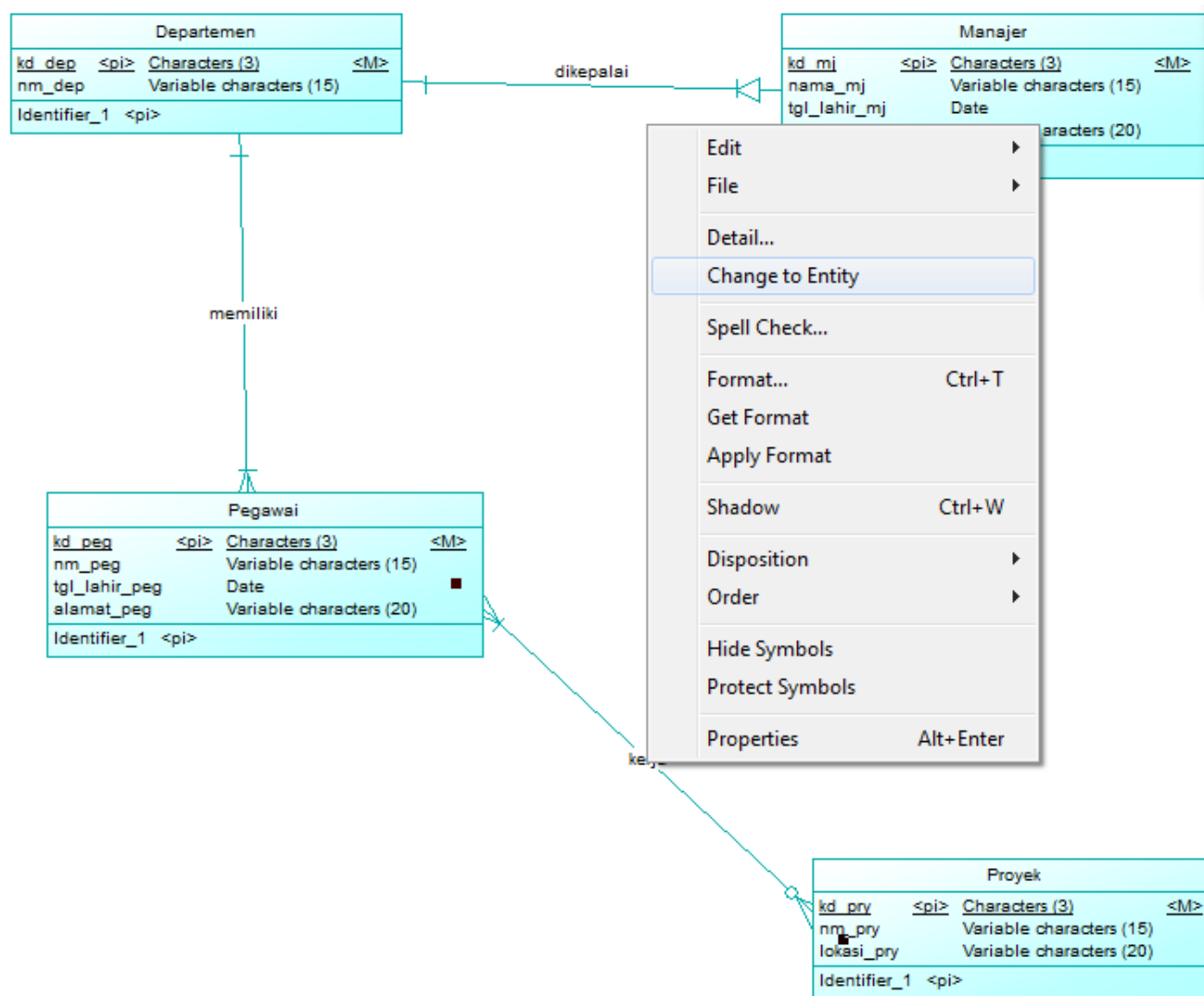

Doble klik pada relasi kerja

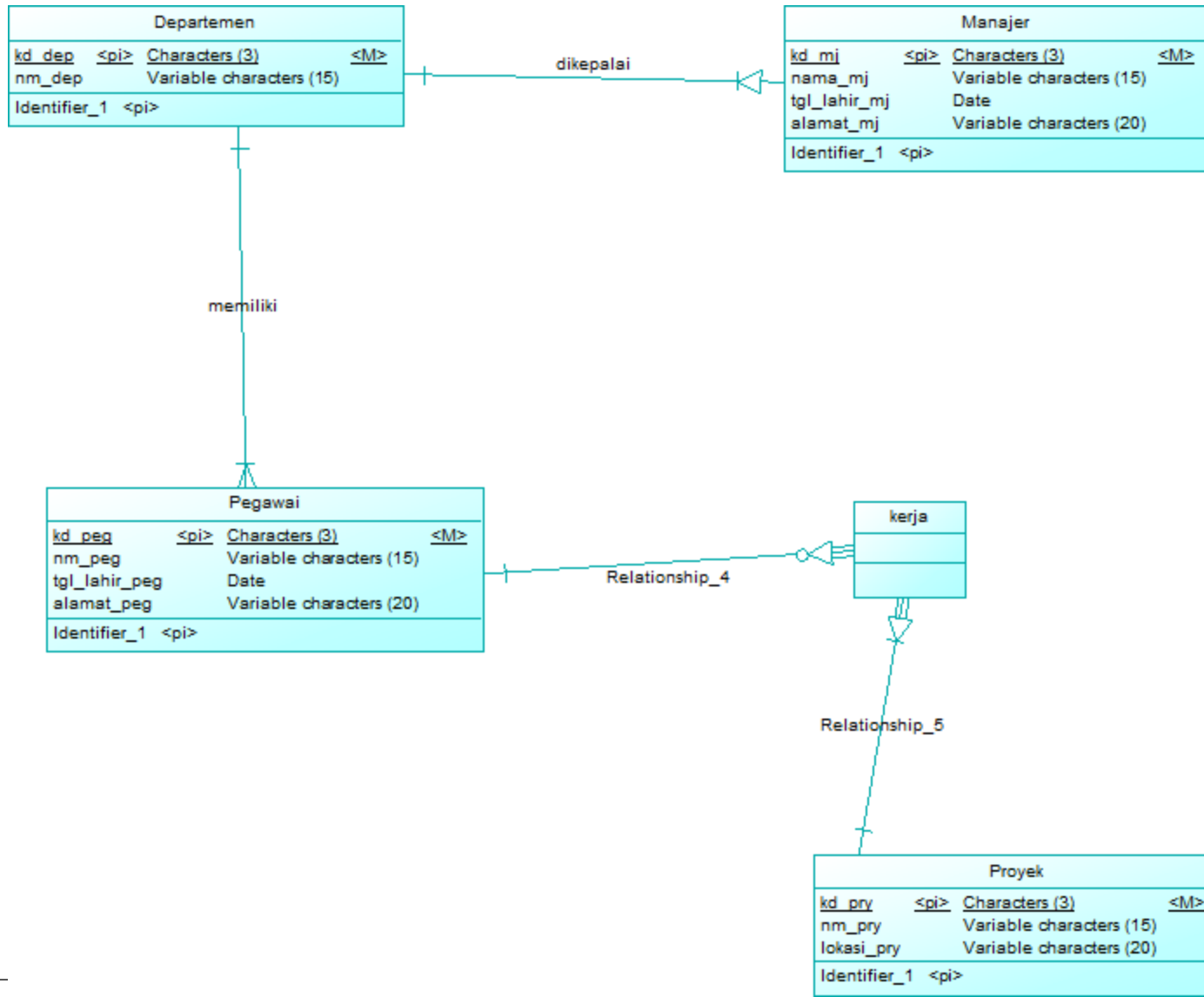

Hasil akhir Conceptual Data Model

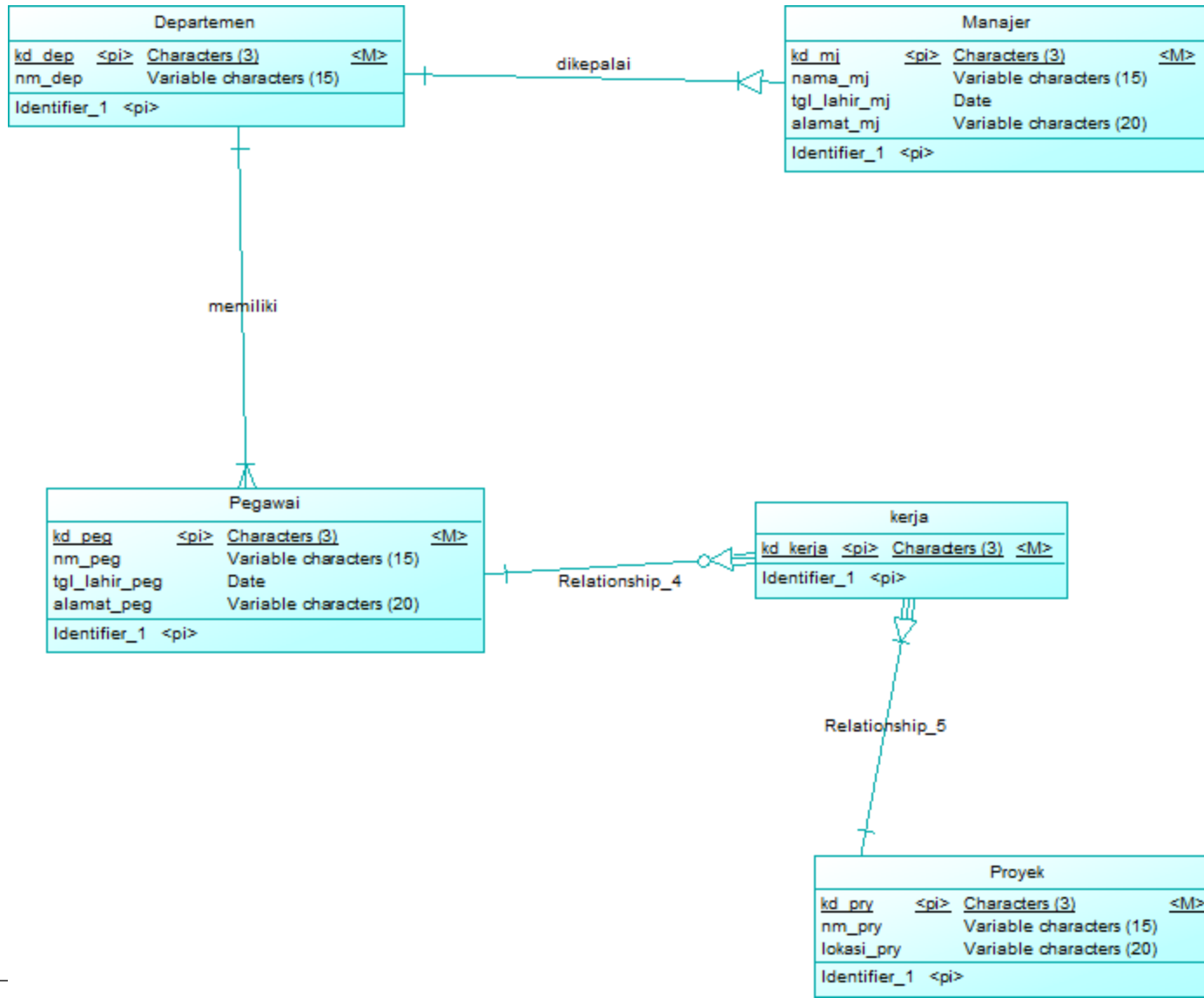

Tools >> Generate Physical Data Model

The screenshot shows the PowerDesigner application window. The title bar reads "PowerDesigner - [CDM ConceptualDataModel_1, Diagram_1 - F:\STIKI\KULIAH\DATA INTEGRATION\Power Designer Latihan\ConceptualDataModel_1.cdm]". The menu bar includes "File", "Edit", "View", "Model", "Symbol", "Report", "Repository", "Tools", "Window", and "Help". The "Tools" menu is open, listing various options. The option "Generate Physical Data Model..." is highlighted, with the keyboard shortcut "Ctrl+ Shift+ P".

The main workspace displays a UML class diagram with the following entities and relationships:

- Manajer**: Attributes include `kd_mj` (primary key, Characters (3), multiplicity <M>), `nama_mj` (Variable characters (15)), `tgl_lahir_mj` (Date), `alamat_mj` (Variable characters (20)), and `Identifier_1` (primary key).
- kerja**: Attributes include `kd_kerja` (primary key, Characters (3), multiplicity <M>) and `Identifier_1` (primary key).
- Proyek**: Attributes include `kd_prj` (primary key, Characters (3), multiplicity <M>) and `nm_prj` (Variable characters (15)).

Relationships are shown as follows:

- A generalization relationship (solid line with hollow triangle) from **Manajer** to **kerja**.
- A relationship named "Relationship_5" between **kerja** and **Proyek**.

On the left side, there are two entity diagrams partially visible, one for **kd_dep** and one for **kd_peg**. On the right side, a "Palette" window is open, showing various tool icons for diagram manipulation.

Pilih DBMS yang digunakan

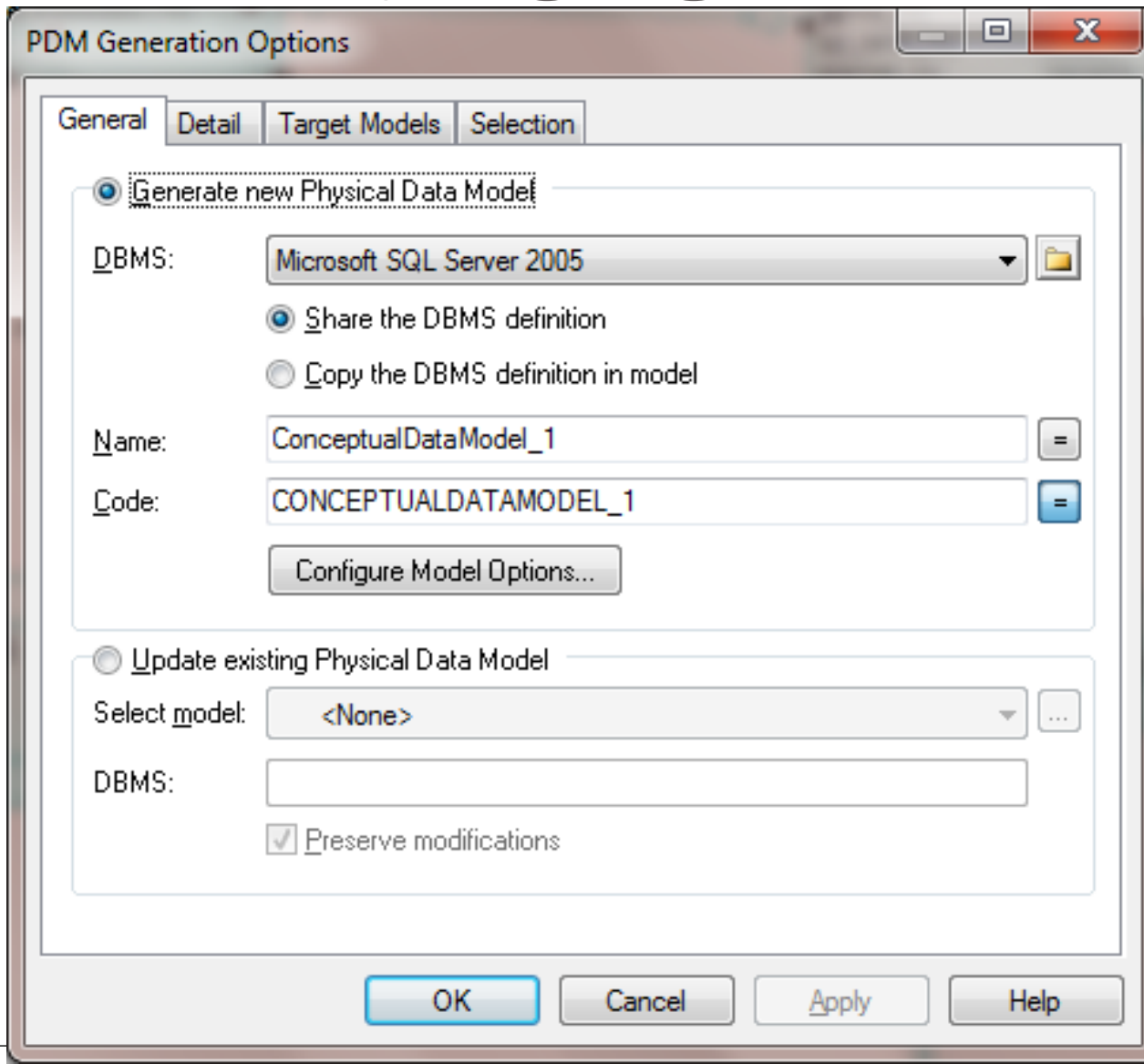

Hasil akhir Physical Data Model

